

BBS/ENG

STAINLESS STEEL-BALL VALVE WITH THREADED PORTS

VERSION **A**
DN 4-50 | PN 100

FULL BORE

INFORMATION

Ball Valve with threaded ports

/// The lever is included

MATERIALS

Body	Stainless steel
Screw connections	Stainless steel
Ball	Stainless steel
Sealings	PTFE
O-Rings	FPM
Stem	Stainless steel

OPTIONS

/// **Mounting holes**
(BBS/ENG Version A-M)
Surcharge: 23,50 €
**(Only for diameters DN32 to DN50,
< DN32 please choose BBS/EBG)**

/// **Locking device**
(BBS/ENG Version A-L)
Surcharge: 53,00 €

/// Special designs on request

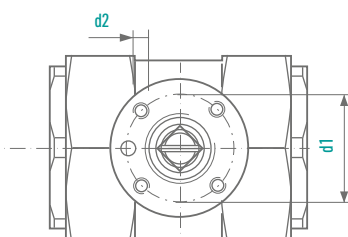
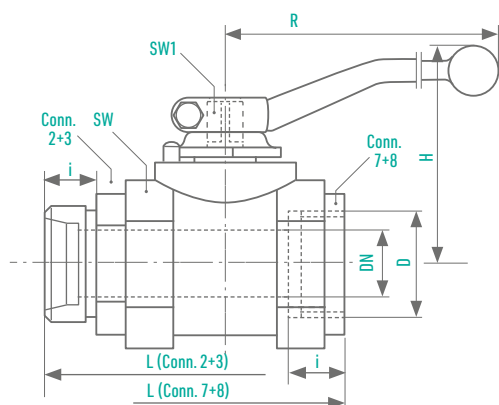

Mounting holes optional
(BBS/ENG Version A-M)
See Data Sheet: „OPTIONS“

Connection	DN [mm]	OD Pipe [mm]	PN [bar]	D [mm]	i [mm]	L [mm]	SW [mm]	H [mm]	R [mm]	SW1 [mm]	Weight [kg]	Order Number
2 For compression fitting, light series, DIN 2353	4	6	100	M 12 x 1,5	10	76	24	44	60	8	0,3	0272011
	6	8	100	M 14 x 1,5	10	76	24	44	60	8	0,3	0272012
	8	10	100	M 16 x 1,5	11	76	24	44	60	8	0,3	0272013
	10	12	100	M 18 x 1,5	11	80	30	51	90	8	0,4	0272014
	12	15	100	M 22 x 1,5	12	96	36	55	100	10	0,7	0272015
	16	18	100	M 26 x 1,5	12	105	41	68	130	10	0,8	0272016
	20	22	100	M 30 x 2	14	110	46	70	130	10	1,1	0272017
	25	28	100	M 36 x 2	14	120	55	82	180	12	1,6	0272018
	32	35	25	M 45 x 2	16	145	70	110	205	16	3,5	0273900
	40	42	25	M 52 x 2	16	150	80	120	300	16	4,5	0273901
3 For compression fitting, heavy series, DIN 2353	4	8	100	M 16 x 1,5	12	76	24	44	60	8	0,3	0272019
	6	10	100	M 18 x 1,5	12	76	24	44	60	8	0,3	0272020
	8	12	100	M 20 x 1,5	12	76	24	44	60	8	0,3	0272021
	10	14	100	M 22 x 1,5	14	80	30	51	90	8	0,4	0272022
	12	16	100	M 24 x 1,5	14	96	36	55	100	10	0,7	0272023
	16	20	100	M 30 x 2	16	105	41	68	130	10	0,8	0272024
	20	25	100	M 36 x 2	18	110	46	70	130	10	1,1	0272025
	25	30	100	M 42 x 2	20	120	55	82	180	12	1,6	0272026
	32	38	25	M 52 x 2	22	145	70	110	205	16	3,5	0273902
	7 BSP female thread DIN ISO 228/1	4	-	100	G 1/8	11	50	24	44	60	8	0,3
6		-	100	G 1/4	12,5	50	24	44	60	8	0,3	0272028
8		-	100	G 3/8	12,5	55	28	44	60	8	0,3	0272029
10		-	100	G 3/8	12,5	60	30	51	90	8	0,4	0272030
12		-	100	G 1/2	15	75	36	55	100	10	0,6	0272031
16		-	100	G 1/2	15	75	41	68	130	10	0,7	0272032
20		-	100	G 3/4	18	80	46	70	130	10	0,8	0272033
25		-	100	G 1	20	90	55	82	180	12	1,2	0272034
32		-	25	G 1 1/4	21	110	70	110	205	16	3,0	0273903
40		-	25	G 1 1/2	23	120	80	120	300	16	4,0	0273904
8 NPT-Innen/Whitende ANSI/ASME B 1201	50	-	25	G 2	24	140	100	130	300	16	6,0	0273905
	4	-	100	NPT 1/8	11	50	24	44	60	8	0,3	0272035
	6	-	100	NPT 1/4	12,5	50	24	44	60	8	0,3	0272036
	8	-	100	NPT 3/8	12,5	55	28	44	60	8	0,3	0272037
	10	-	100	NPT 3/8	12,5	60	30	51	90	8	0,4	0272038
	12	-	100	NPT 1/2	15	75	36	55	100	10	0,6	0272039
	16	-	100	NPT 1/2	15	75	41	68	130	10	0,7	0272040
	20	-	100	NPT 3/4	18	80	46	70	130	10	0,8	0272041
	25	-	100	NPT 1	20	90	55	82	180	12	1,2	0272042
	32	-	25	NPT 1 1/4	21	110	70	110	205	16	3,0	0273906
40	-	25	NPT 1 1/2	23	120	80	120	300	16	4,0	0273907	
50	-	25	NPT 2	24	140	100	130	300	16	6,0	0273908	

OPTIONS

MOUNTING HOLES, OPTIONAL (VERSION -M)

Subject to surcharge unless otherwise described

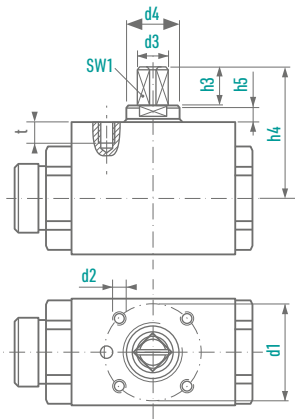

Models

**BMG
BHG
EBG**

**Connection-
types
2,3,7,8,40**

DN [mm]	d1	d2	t	SW1	d3	h3	h4	d4	h5
4	25	M5	6	8	10	10	29	-	-
6	25	M5	6	8	10	10	29	-	-
8	25	M5	6	8	10	10	29	-	-
10	25	M5	6	8	10	10	36	16	5
12	36	M6	8	10	12	14	47	20	5
16	36	M6	8	10	12	14	49	20	5
20	50	M6	8	10	12	14	51	20	5
25	50	M6	8	12	15	14	55	23	5,5



Models

MKG

**Connection-
types 2,3,7,8**

DN [mm]	d1	d2	t	SW1	d3	h3	h4	d4	h5
32	50	M8	10	16	20	19,5	77	29	7
40	50	M8	10	16	20	19,5	83	29	7
50	50	M8	10	16	20	19,5	90	29	7

OPTIONS

LOCKING DEVICE, OPTIONAL (VERSION -L)

Subject to surcharge

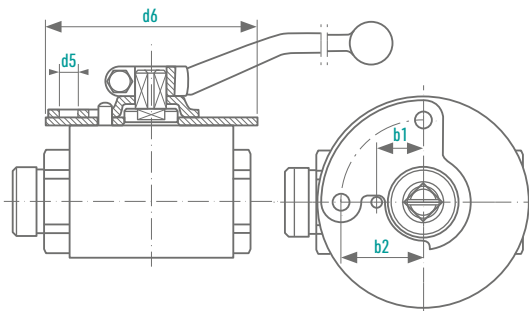

Models	DN [mm]	b1	b2	d5	d6
KMG KHG MKG ENG	4	12	23	7,5	60
	6	12	23	7,5	60
	8	12	23	7,5	60
	10	13,5	23	7,5	65
	12	17,5	31	7	80
	16	17,5	31	7	80
	20	17,5	31	7	80
	25	17,5	31	7	80
	32	24	41	7	100
	40	24	41	7	100
50	24	41	7	100	

Connection types
2,3,7,8, 40

BAUREIHEN	DN [mm]	b1	b2	d5	d6
BMG BHG EBG	4	12	23	7,5	60
	6	12	23	7,5	60
	8	12	23	7,5	60
	10	13,5	23	7,5	65
	12	17,5	31	7	80
	16	17,5	31	7	80
	20	17,5	31	7	80
25	17,5	31	7	80	

Connection types
2,3,7,8,40